

63A 2 + 2 FASTBACK



EXTERIOR STYLING AND FEATURES

For 1967, the 2 + 2 Fastback has been completely restyled with all-new body sheetmetal and roof, portraying even more of the "Gran Turismo" sports flair. The new roof presents a sleek swept-back appearance with smooth flowing lines. The large rear window and short deck lid are fully integrated into the design, carrying the roofline to the extreme rear of the car. A series of thin air louvers are positioned on the roof rear quarter, and are a part of the functional flow-through ventilation system.

Below the roof, the 2 + 2 Fastback is similar to the Hardtop and Convertible.

- Deeply inset grille with a crisp mesh appearance. Familiar Mustang ornament positioned at grille center.
- New radial spoke design wheel covers are standard.
- Highly sculptured body side panels that terminate into twin simulated air scoops. Full-length bright-metal rocker panel molding.
- FORD on the hood leading edge, MUSTANG lettering and emblem on the front fenders, and MUSTANG lettering on the deck lid.
- Bright-metal window trim all-around.
- Three bright-metal trimmed taillights/turn signals at either side of the concave rear panel. Back-up lights in lower rear panel. Fuel filler cap with styled "knock-off" design that displays a Mustang emblem.

INTERIOR STYLING AND FEATURES

- All-new sports styled interior with foam-padded twin bucket seats. Rear seat is fixed in place with sport deck optional.
- New door trim panels with horizontal pleated design, trimmed with bright-metal moldings. Choice of seven all-vinyl trims — black, blue, red, saddle, ivy gold, aqua and parchment.
- New instrument panel and cluster. Large, easy to read gauges for fuel, oil pressure, amps and temperature.
- All major items, including the headlining, are color-keyed to the interior trim selection.
- Expanded standard safety package. (see page 6)
- Additional standard features — 16-inch three-spoke steering wheel . . . long wearing nylon-rayon carpeting molded to the floor contour . . . suspended accelerator pedal . . . front seat arm rests . . . instrument-panel-mounted glove box . . . courtesy lights under instrument panel and quarter trim panels operated by door switches.

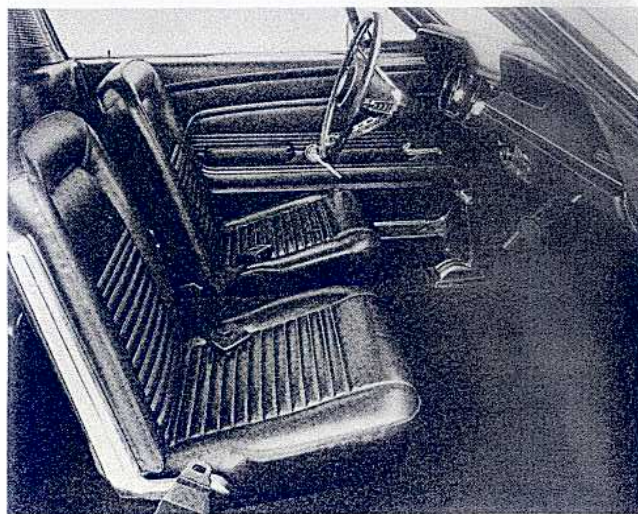

MAJOR SPECIFICATIONS

Wheelbase	108"
Tread — Front	6-Cyl.-57.9" — V-8-58.1"
— Rear	6-Cyl.-57.9" — V-8-58.1"
Length — Overall	183.6"
Width — Overall	70.9"
Height — Overall	51.6"
Usable Luggage Capacity	5.1 cu ft

Front Compartment Dimensions —	
Effective Head Room	37.3"
Maximum Effective Leg Room	41.8"
Hip Room	53.9"
Shoulder Room	53.4"
Curb Weight (6-Cyl. — Std. Transmission)	2723 lbs

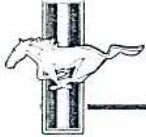

MUSTANG POWER TEAMS

POWER TEAM AVAILABILITY

The 1967 Mustang is available with 13 engine-transmission combinations — ranging from the economical 200 Six with a three-speed manual transmission to the powerful 390 4v GT V-8 with four-on-the-floor. With this wide selection, buyers can tailor a power team to fit their motoring needs.

ENGINES

The 200-cubic-inch Six with a rating of 120 horsepower is standard equipment with all Mustangs. Where initial cost is the prime requisite, this engine is the logical choice. It provides spirited performance and maximum economy of operation. Features include a seven main bearing crankshaft that provides ultra-smooth operation, a dual element choke for all-weather good starting, and redesigned combustion chambers for maximum efficiency.

The 289-cubic-inch 2v V-8 with a 200-horsepower rating is the base optional engine. The most popular of Ford engines, it provides excellent performance in a car of Mustang's size. Features include the use of regular grade fuel, a new valve train that increases durability, and a new 2-venturi carburetor.

The optional 289-cubic-inch 4v V-8 provides a further increase in performance with a rating of 225 horsepower. Under normal driving conditions, it uses only a small percentage of its horsepower, with a large reserve ready for emergency situations. A new Autolite carburetor has been installed for 1967 that increases efficiency and performance through the entire driving range.

The third optional V-8 engine is the 289-cubic-inch 4v High-Performance V-8 with a rating of 271 horsepower. Proven in thousands of performance events, this engine delivers outstanding performance with the utmost reliability. Included with this engine are special drive line and suspension components and F-70-14 WSW Wide-Oval tires on six-inch rims. Available with GT Equipment Group and either 4-speed manual or Cruise-O-Matic at extra cost.

The top engine for 1967 is the 390-cubic-inch 4v GT V-8. With its 320-horsepower rating, it provides commanding performance in any driving situation. Like the 289 High-Performance V-8, it includes special drive line and suspension components and F-70-14 WSW Wide-Oval tires on six-inch rims. Available with or without GT Equipment Group.

Refer to Section H — Engine Section for complete descriptions and specifications of all Mustang engines.

TRANSMISSIONS

Three-speed manual transmissions are included as standard equipment with all engines except the 289 High-Performance and 390 GT V-8's. These transmissions are the constant-mesh type that fully synchronize in all forward gears.

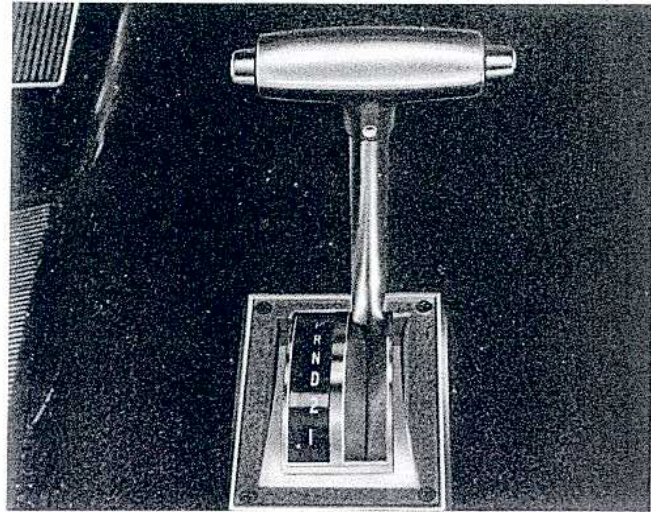

Available with all engines, the smooth shifting Select Shift Cruise-O-Matic transmission features an extremely versatile shift pattern for 1967. This shifting arrangement permits both manual and fully automatic operation — whichever the driver desires for the immediate road conditions or driving situation. Refer to page 4 of I-Transmission Section for a complete description of the capabilities of this unique transmission.

A four-speed constant-mesh manual transmission is optional with all engines except the 200 Six. This transmission is fully synchronized in all forward gears, permitting upshifts and downshifts at reasonable car speeds without gear clash or noise. When ordered with 289 4v High-Performance or 390 4v engine it will include tachometer and trip odometer.

Refer to Section I — Transmission and Drive Line for complete descriptions and specifications of all Mustang transmissions.

POWER TEAM SELECTION

ENGINES	TRANSMISSIONS			REAR AXLE RATIOS					
	3-Speed* Manual	4-Speed Manual	Cruise- O-Matic	3-Speed*		4-Speed Manual		Cruise- O-Matic	
				Std.	Opt.	Std.	Opt.	Std.	Opt.
Std. — 200 Six — 120 HP	Std.	N/A	Opt.	3.20	—	—	—	2.83	3.20
Opt. — 289 2v V-8 — 200 HP	Std.	Opt.	Opt.	2.80	3.00++	2.80	**3.00+	2.80	**3.00+
Opt. — 289 4v V-8 — 225 HP	Std.	Opt.	Opt.	3.00+	—	3.00+	—	3.00+	—
Opt. — 289 4v Hi-Perf. V-8 — 271 HP	N/A	Opt.	Opt.	—	—	3.50	3.89	3.50	3.89
Opt. — 390 4v GT V-8 — 320 HP	#	Opt.	Opt.	3.00	3.25++	3.00	3.25++	3.00	3.25++

* 3-Speed fully synchronized transmission.

** Mandatory ratio with F-70-14 Wide-Oval tires.

+ Also available with optional limited-slip differential.

++ Available only with optional limited-slip differential.

HD 3-Speed Manual req'd. at extra cost.



MUSTANG FEATURES

STANDARD EQUIPMENT

	Hardtop	Convertible	2 + 2 Fastback		Hardtop	Convertible	2 + 2 Fastback
Air Cleaner Filter*	X	X	X	Heater and Defroster — Fresh Air	X	X	X
Accelerator Pedal — Suspended - Type	X	X	X	Hood Latch — Single - Action	X	X	X
Alternator — 38 - Amp	X	X	X	Horns — Dual	X	X	X
Ash Tray — Front	X	X	X	Instrument Panel — Padded	X	X	X
Arm Rests — Front — Energy - Absorbing	X	X	X	Insulated Body	X	X	X
Arm Rests — Ash Trays — Rear	X	X	X	Jack, Scissors - Type — Body Side	X	X	X
Back - Up Lights	X	X	X	Lamps Bulbs — Extended - Life	X	X	X
Battery — "Sta - Ful" Design	X	X	X	Lubrication, Chassis — 36,000 - Mile	X	X	X
Body — Rust Resistant	X	X	X	Maintenance — Twice - A - Year	X	X	X
Brakes — Self - Adjusting — Dual System	X	X	X	Mirror — Inside Rearview, Day/Nite	X	X	X
Bucket Seats — Foam - Padded, Adjustable	X	X	X	Mirror — Outside Rearview — Remote Control	X	X	X
Carpets — Nylon - Rayon, Molded	X	X	X	Molding — Rocker Panel			X
Choke — Automatic	X	X	X	Muffler — Aluminized	X	X	X
Cigarette Lighter	X	X	X	Oil Filter — 6,000 - Mile	X	X	X
Coat Hooks	X	X	X	Scuff Plates — Aluminum	X	X	X
Coolant — 2 - Year or 36,000 - Mile	X	X	X	Seat Belts — Front and Rear	X	X	X
Courtesy Lights — Door Switches	X	X	X	Steering Wheel — Deep - Dish, Safety - Type	X	X	X
Curved Side Glass	X	X	X	Sun Visors — Padded, Color - Keyed	X	X	X
Door Checks — Two - Stage	X	X	X	Thermostat — 195 - Degree	X	X	X
Door Hinges — Bronze - Bushed	X	X	X	Transmission Lever — Tunnel - Mounted	X	X	X
Door Latches — Bear - Hug	X	X	X	Transmission — 3 - Speed Manual	X	X	X
Door Trim — All - Vinyl	X	X	X	Turn Signals — w/Lane Change	X	X	X
Emergency Flashers, 4 - Way	X	X	X	Upholstery — All - Vinyl	X	X	X
Engine — 200 Six	X	X	X	Valve Lifters — Hydraulic	X	X	X
Finish — Super Diamond Lustre Enamel	X	X	X	Ventilation — Cowl - Aire Intakes	X	X	
Front Fenders — Bolt - On	X	X	X	Ventilation — Cowl - Aire plus Roof Vent Outlets			X
Fuel Tank — 16 - Gallon	X	X	X	Wheel Covers — Full			X
Glass — Safety	X	X	X	Windshield Washers	X	X	X
Glove Box — Instrument - Panel - Mounted	X	X	X	Windshield Wipers — 15" Electric — 2 - Speed	X	X	X
Headlining — Color - Keyed Vinyl	X		X				

* 12,000 miles with closed crankcase emission system.

SAFETY FEATURES

A broad range of new and improved safety features will be standard equipment on all 1967 Mustang models. Highlights of these safety features are:

DUAL HYDRAULIC BRAKE SYSTEM WITH WARNING LIGHT — Dual master cylinders control the front brakes and the rear brakes independently. Should there be a fluid loss in the front brakes, the rear brakes will still be operational, and vice versa. If a leak should develop, the driver is alerted by a warning light on the instrument panel that lights when the brakes are applied and signals the need for immediate repairs. (see page 11)

4-WAY EMERGENCY FLASHER — The driver can put all four turn signals into operation simultaneously to warn of an emergency situation. The emergency flasher control switch is located conveniently on the right side of the steering column.

ENERGY-ABSORBING ARM RESTS — The 1967 Mustang's new arm rests have energy-absorbing properties in a lateral plane, yet they provide firm vertical arm support with a soft foam cushion. The new design has a polypropylene honeycomb-type core surrounded and filled with urethane foam and covered with soft vinyl. The honeycomb is positioned

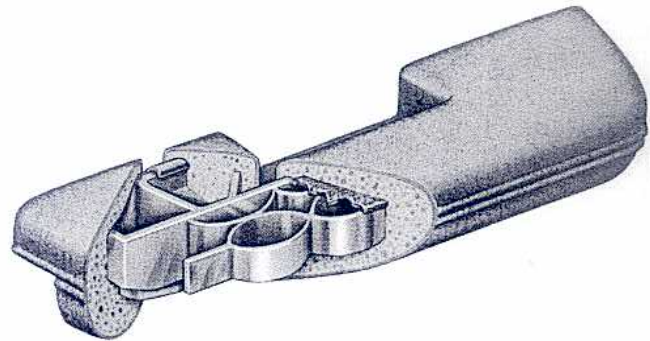

vertically to give the necessary strength, yet will collapse laterally to minimize the possibility of injury during a collision.

IMPACT-ABSORBING STEERING WHEEL WITH DEEP-PADDED HUB — The impact-absorbing deep-dish steering wheel, pioneered by Ford, is now supplemented by the addition of a deep-padded hub designed to progressively collapse on impact. The hub consists of an inner core of molded urethane foam, an outer layer of polyvinylchloride, covered with soft vinyl. The steering wheel also yields on impact, yet gives firm control when driving.

REARVIEW MIRRORS — A day/nite inside mirror with shatter resistant flexible backed glass and break-

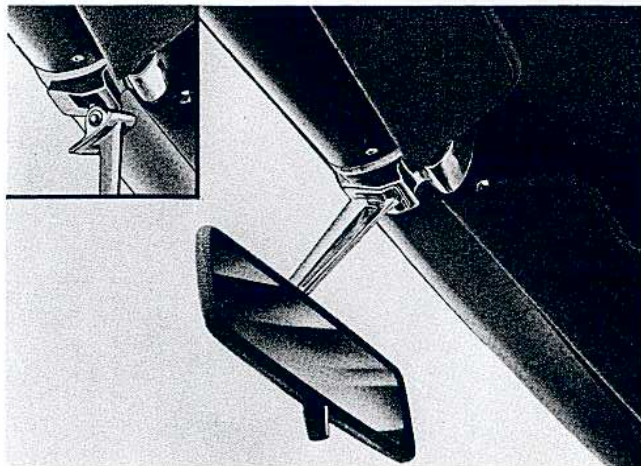

away or double pivot support and an outside remote control mirror are standard equipment on all 1967 Mustang models.

POSITIVE DOOR LOCK BUTTONS — To prevent inadvertent opening of car doors from the inside, all Mustang inside lock buttons are of the non-overriding type. Once the lock button is depressed, the door handle will not override and unlock the door. The driver or passenger must first lift the button, then open the door with the handle.

TURN INDICATORS WITH LANE-CHANGING SIGNAL FEATURE — This new feature, when used properly, will eliminate driving with the turn signals operating after a lane change maneuver has been completed. The driver holds the turn indicator lever in an intermediate position to signal his intention to change lanes to either right or left. When the lever is released, a spring returns it to the straightaway posi-

tion, cancelling the signal. Turn signals operate in the conventional way.

PADDED INSTRUMENT PANEL — Safety padding used on the Mustang instrument panel contains extra energy-absorbing properties. The padding is formed to the contour of the instrument panel providing a convenient hood over the instruments to minimize glare and reflection. It is covered with a low-gloss vinyl.

TWO-SPEED WINDSHIELD WIPERS AND WINDSHIELD WASHERS — Electric powered two-speed windshield wipers give more reliable, consistent action under all driving conditions. Windshield washers, when put into operation, automatically energize the wipers. Both washers and wipers feature easy operation and positive action.

ADDITIONAL STANDARD SAFETY FEATURES—

- Front and rear seat belts.
- Front seat belt retractors.
- Padded sun visors.
- Padded windshield pillars.
- Thick laminate safety plate glass windshield.
- Safety designed instrument panel and controls.
- Reduced glare instrument panel and wiper arms and blades.
- Double-yoke safety door latches and safety hinges.
- Back-up lights.
- Uniform shift quadrant with automatic transmission.
- Front seat shoulder harness anchors.
- Tire safety rims.
- Corrosion-resistant brake lines.

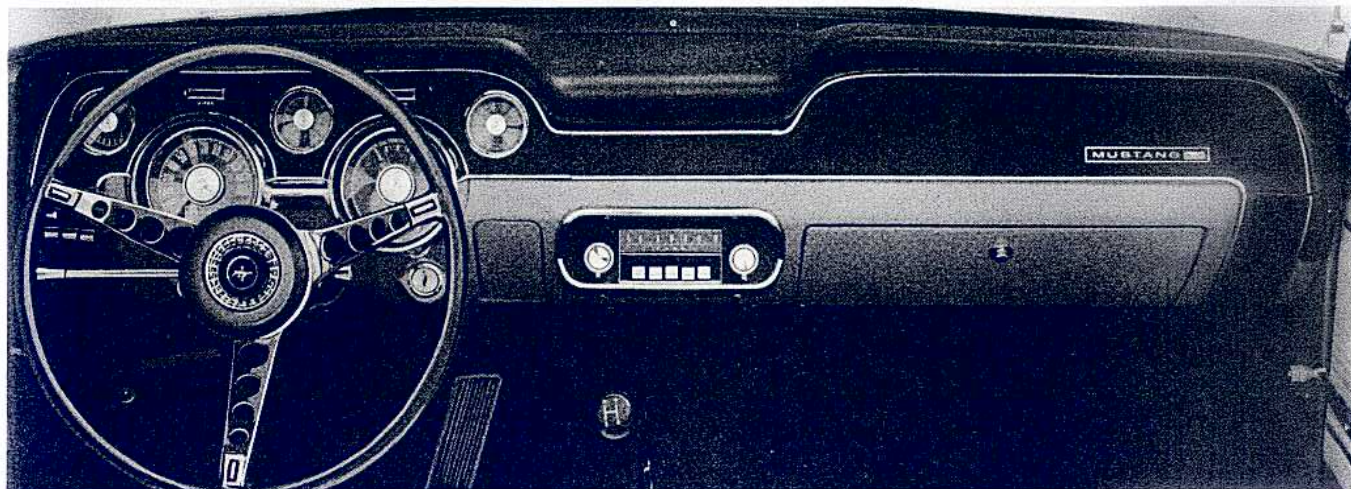

INSTRUMENT PANEL

The instrument panel and cluster are all-new for 1967. The cluster features full instrumentation contained in two large and three small pods directly in front of the driver, recessed under a large safety padded hood.

- The 120-mph speedometer and odometer are located in the large left-hand cluster pod. The large right-hand pod contains the alternator and oil pressure gauges.
- The small left-hand pod houses the fuel gauge and the right-hand pod houses the temperature gauge. The center pod houses the optional electric clock.
- The windshield wiper switch is directly above the large

left-hand pod, and the brake system warning light is directly above the right pod.

- The heater controls are at the extreme left below the cluster. The light switch is to the left of the steering column and the four-position ignition switch is to the right.
- The left air vent control is attached to the right side of the steering column — the right vent is controlled by opening a door in the heater housing.
- The pullout ash tray with concealed cigarette lighter is directly to the right of the ignition switch. The large swing-down glove box is located at the right of the panel.
- An optional AM radio or AM Radio/StereoSonic tape system may be installed at the center of the panel.

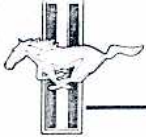

MUSTANG FEATURES

RIDING COMFORT

Outstanding characteristics of the Mustang since its introduction have been a smooth, comfortable ride, easy, responsive steering and excellent road handling ability. For 1967, improvements have been made in the suspension, steering and tread to further improve on these characteristics.

- **FRONT SUSPENSION** — the '67 front suspension is all-new and embodies many of the design improvements of the larger cars. Major changes include a two-and-one-half inch longer lower arm and a lower inner pivot on the upper arm. This results in a better wheel attitude under all road conditions for a smoother ride and better control. (refer to page 10)
- **WIDER TREAD** — Both the front and rear treads have been increased approximately two inches — front and rear tread are now a nominal 58 inches. This new wide stance increases roadability and driver control.
- **STEERING LINKAGE** — The steering linkage is all-new for '67 to accommodate the new suspension and tread width increase. In addition, several improvements have been made in the system design. The tie rod ball joints feature polyethylene filled sockets that have low friction characteristics, offering a significant decrease in turning efforts. The polyethylene also has excellent damping characteristics to help prevent feedback of road shock through the steering system. Other advances include a reduction in the turning diameter and a decrease in the overall steering ratio with both the manual and power systems. These changes offer better maneuverability when parking and easier, more responsive steering on the open road. (refer to page 9)

REVERSIBLE KEYS AND KEYLESS LOCKING SYSTEM

Ford's unique design reversible keys and a keyless locking system are used on all Mustangs. The reversible keys have two identical sides and may be inserted conveniently into the lock with either side up. They are used on all locks, including the ignition switch. The keyless locking system offers extra convenience by permitting the doors to be locked by depressing the inside lock button, then holding the outside push-button in as the door is closed.

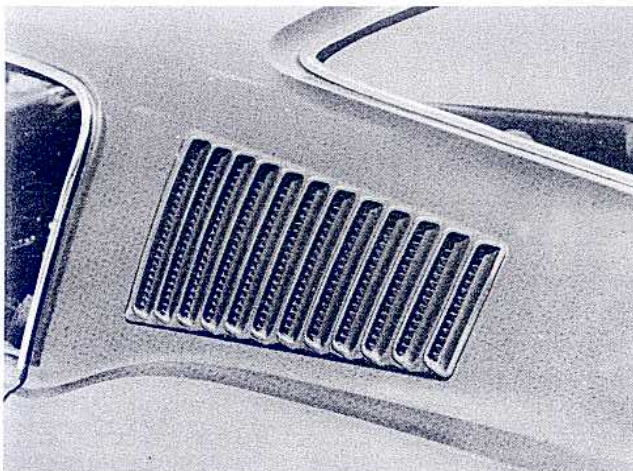

2 + 2 FASTBACK VENTILATION SYSTEM

Standard equipment on the 2 + 2 Fastback is a "Silent-Flo" ventilation system that incorporates functional

louvers styled into the roof rear quarters. The vents are manually controlled from the inside — from full closed to full open. With the vents and front air inlets open, and the windows closed, the speed of the car promotes quiet, fresh air circulation throughout the passenger compartment.

STANDARD LUXURY FEATURES

The 1967 Mustang includes a host of luxury features and appointments as standard equipment, providing extra sports appeal, comfort, convenience and pride of ownership.

FULL WHEEL COVERS — Standard on 2 + 2 Fastback the cleanly styled wheel covers feature a radial spoke design that emphasizes the full circular wheel cutouts and sports styling of the exterior sheet-metal. The center hub is slightly depressed and contains an insert with a Mustang emblem.

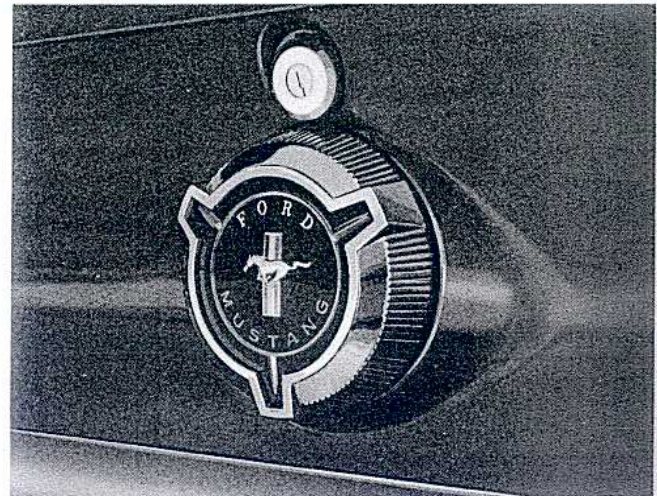

STYLED FUEL FILLER CAP — The convenient center located fuel filler cap features a three-blade simulated "knock-off" design that adds to the sports decor of the rear styling. The center of the cap contains a plastic insert with Ford and Mustang lettering plus the attractive red, white and blue Mustang emblem. For theft protection, the cap is attached to the body with a firmly anchored hidden cable.

ADDITIONAL LUXURY FEATURES include —

- Nylon-rayon carpeting molded to the floor contour.
- All-vinyl upholstery in seven rich and durable colors.
- Twin front bucket seats that are sculptured and foam-padded for maximum comfort and tastefully trimmed in bright metal.
- Color-keyed all-vinyl headlining in Hardtop and 2 + 2 Fastback models.
- Gauges for fuel level, engine temperature, alternator, and oil pressure.
- Suspended accelerator pedal that gives smooth, responsive action and permits easy cleaning of the front floor area.
- Courtesy lights with door-operated switches. Hardtop has dome-light; Fastback and Convertible have under-instrument panel lights.
- 14-inch low-profile tires that offer a smooth ride and excellent stability.

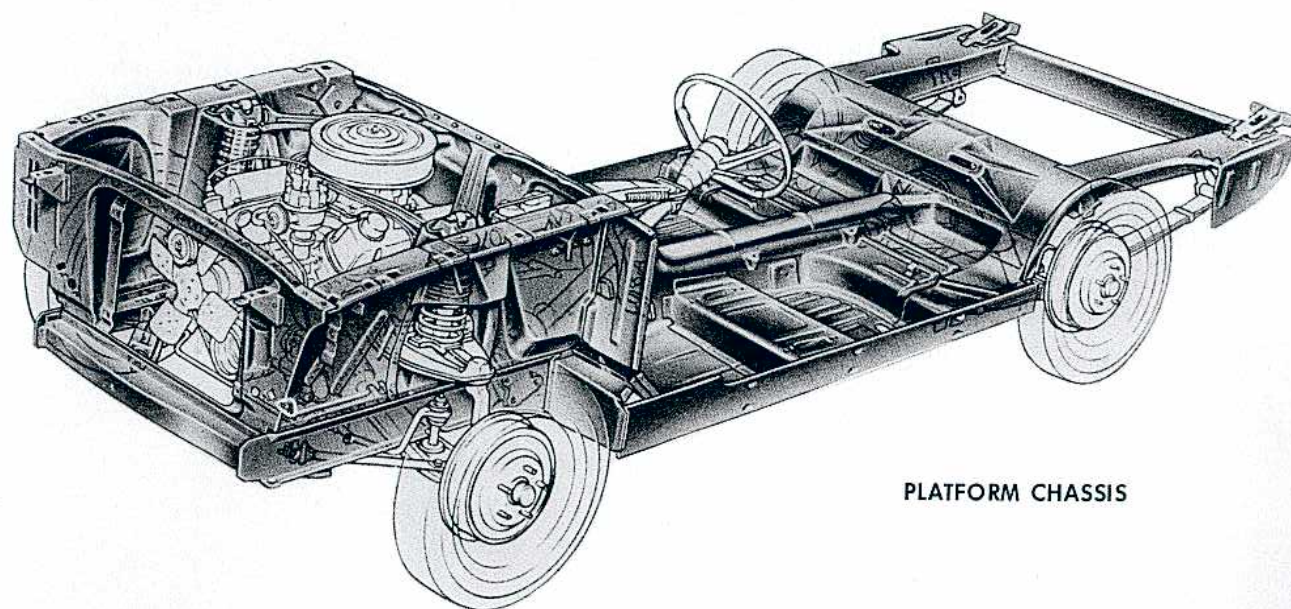

PLATFORM CHASSIS

PLATFORM CONSTRUCTION

The platform construction of the Mustang chassis is a Ford "first" in the American mass market. Based on sound engineering principles, this type of construction has many advantages and is one of the main reasons for the smooth riding characteristics and the rattle-free body of the Mustang.

The platform carries the body on the top, encloses the engine, and provides attaching points for the various chassis components. It also provides the strong basic structure, or foundation, of the car. The platform is made up of box-section front and rear side rails tied in securely to heavy boxed-in rocker panels. These components are connected by five heavy-gauge crossmembers to form an extra strong ladder-type framing under the car. The front and rear side rails extend partially under, and are welded to, the floor pan. The full-depth, full-length tunnel down the center of the floor pan adds a "backbone," giving the structure maximum rigidity. The full-depth side panels, in the engine compartment, are welded to the front side rails at the bottom and to the cowl at the rear. The tops of these panels are pressed over forming a wide flange, increasing front end rigidity. A one-piece stamping with a deep channel section at the top connects the side panels across the front.

STEERING

The Mustang steering system is of the parallelogram linkage-type with a cross link and idler arm. The steering gear used is Ford's Magic-Circle recirculating ball-and-nut type. All-new components are used to accommodate the new front suspension and increased tread width.

Incorporation of polyethylene filled sockets in all the ball joints provides lower friction characteristics and reduces overall steering effort. In addition, the polyethylene provides better damping to help reduce shock feedback through the steering system.

The manual steering ratio is 25.3 to 1, compared to the previous 27 to 1, offering faster, more responsive steering with less effort.

A faster ratio steering gear is used when either the optional competition handling package or optional power steering is installed. This gear provides an overall steering ratio of 20.3 to 1 and will turn from lock-to-lock in 3.6 turns.

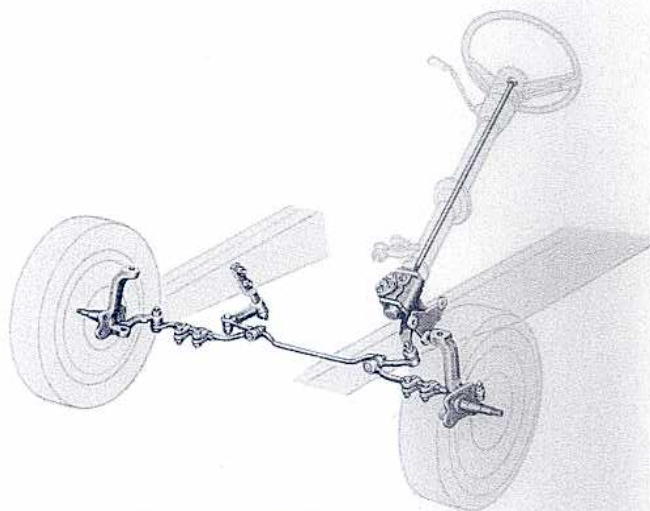

MUSTANG MANUAL STEERING

STEERING SPECIFICATIONS

Linkage	Parallelogram with Cross Link and Idler Arm
Gear Type	Magic-Circle Recirculating Ball
Overall Steering Ratio	
- Manual	25.3 to 1
- Power	20.3 to 1
Steering Wheel Diameter	16 inches
Steering Wheel Turns (lock-to-lock)	
- Manual	4.6
- Power	3.6
Turning Diameter (curb-to-curb)	37.2 feet

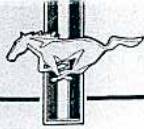

MUSTANG BODIES

BODY SPECIFICATIONS

All dimensions are in inches unless otherwise specified.	Hardtop	Convertible	2 + 2 Fastback
GENERAL			
Wheelbase	108	108	108
Tread — Front (6-Cyl.)	57.9	57.9	57.9
— Front (V-8)	58.1	58.1	58.1
— Rear (6-Cyl.)	57.9	57.9	57.9
— Rear (V-8)	58.1	58.1	58.1
Height — Overall	51.6	51.6	51.8
Width — Overall	70.9	70.9	70.9
Length — Overall	183.6	183.6	183.6
ENTRANCE ROOM			
Door Opening Width	55.0	55.0	55.0
Door Opening Height (scuff plate to windcord)	31.6	31.2	31.5
Foot Clearance — Front	14.5	14.5	14.5
Entrance Height (seat to windcord)	29.2	28.7	29.0
FRONT SEAT ROOM			
Head Room (effective)	37.4	37.8	37.3
Maximum Leg Room to Accelerator	41.8	41.8	41.8
Hip Room	53.9	53.9	53.9
Shoulder Room	53.4	53.4	53.4
Cushion Height (from floor to crest at front)	9.2	9.2	9.2
Cushion Depth	17.1	17.1	17.1
Steering Wheel to Cushion Clearance	6.2	6.2	6.2
REAR SEAT ROOM			
Head Room (effective)	35.9	35.9	*
Minimum Leg Room	28.8	28.8	*
Hip Room	50.9	43.5	*
Shoulder Room	53.9	43.5	*
Cushion Height (from floor to crest at front)	11.1	11.1	*
Cushion Depth	15.2	15.2	*
LUGGAGE CAPACITY (CU. FT.)			
Usable Luggage Capacity	9.2	7.7	5.1
GLASS AREA (SQ. IN.)			
Side Glass Exposed Surface Area	1073.0	1039.8	913.6
Windshield Exposed Surface Area	1070.4	1070.4	1070.4
Backlight Exposed Surface Area	803.0	513.2	1453.6
Total Glass Exposed Surface Area	2946.4	2623.4	3437.6

* Not applicable



NEW AND IMPROVED OPTIONS

Since its introduction, Mustang has been described as "the car designed to be designed by you." This is made possible by the many options that enable it to take on any level of luxury, comfort, performance, or sports appeal — whatever the preference of the individual owner. For 1967, the option availability has been expanded and refined.

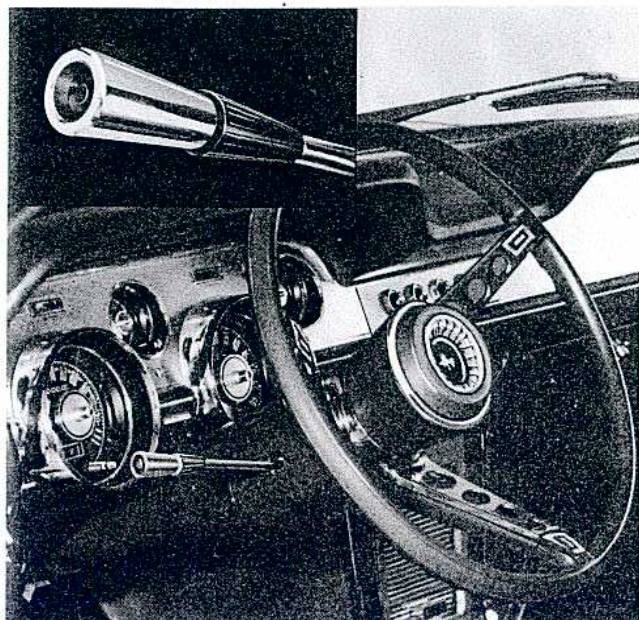

FINGERTIP SPEED CONTROL — A new convenience option is the speed control system, designed into the turn signal lever. Operation is simple, the driver accelerates the car to any speed between 25 and 80 mph, turns the speed control switch on the instrument panel to the "On" position, and pushes the "Set" speed button on the end of the turn signal. The system takes over at this point and maintains the car speed. If a higher speed is desired, the driver merely accelerates and then re-energizes the "Set" speed button. Or, he can hold the button down, and the car will slowly accelerate until the button is released. If the driver has de-energized the speed control by application of the brake, he can return to the previously set speed by rotating the "Resume" sleeve on the end of the lever.

TACHOMETER AND TRIP ODOMETER — The tachometer and trip odometer is a new Mustang option for the motoring enthusiast. The large easy reading 0 to 6000 rpm (0 to 8000 rpm with 289 High-Perf. V-8) tachometer is located in the right-hand instrument cluster pod. The trip odometer is integrated with the speedometer and features an easy action push-button reset button that quickly and easily returns the odometer to zero. When this option is installed, the standard equipment oil pressure and alternator gauges are replaced by lights at the bottom of the tachometer.

TILT-AWAY STEERING COLUMN — A new Ford Motor Company development for 1967, the Tilt-Away steering column offers extra driving comfort and convenience. By merely pushing the turn signal lever forward the wheel can be moved to any of nine tilt positions. Releasing the lever locks the wheel in the selected position. The swing feature is automatic. With the car and engine stopped, and the

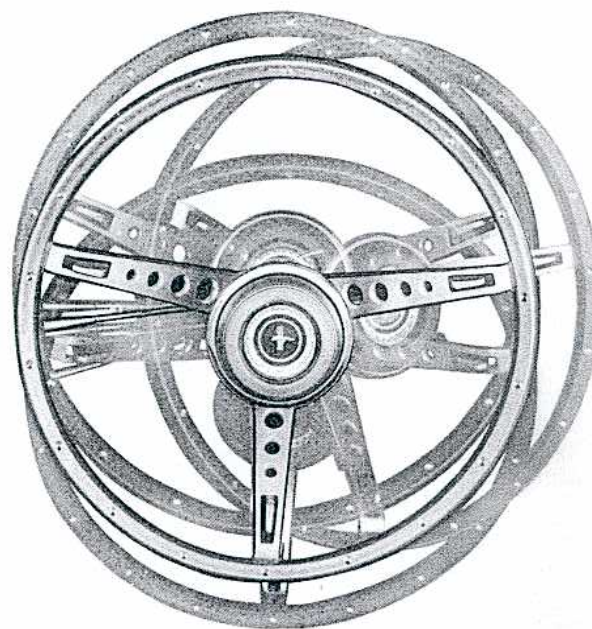

shift lever in "Park," opening the driver's door swings the column up and to the right at a 45-degree angle, providing maximum entry/exit room. After re-entering, and with the door closed, the driver pulls the column back and it locks in position. A built-in "memory" always returns the wheel to the previously adjusted tilt position.

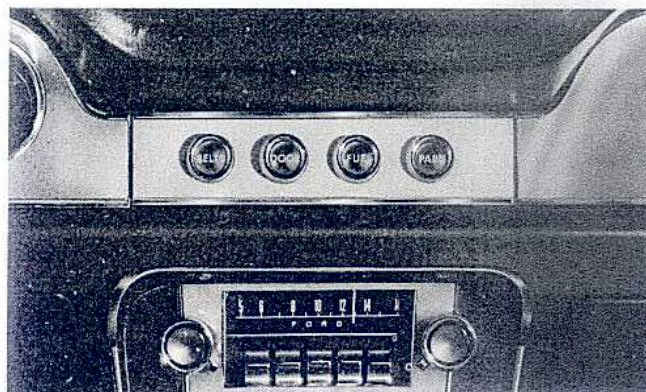

CONVENIENCE PANEL — Available for the first time on the '67 Mustang is the convenience panel that includes warning or reminder lights for door ajar, parking brake, low fuel and seat belts. The panel is installed on the instrument panel above the radio or on the optional console.

GT EQUIPMENT GROUP — The GT Equipment Group provides all the components for outstanding performance, with an exterior appearance that is unmistakably GT. Included are bright beam fog lamps, power assisted front disc-rear drum brakes, narrow/wide/narrow racing stripes full length and low along each side with a GT plaque at the front, F-70-14 Wide-Oval WSW tires, and a heavy-duty suspension that includes stiffer springs, larger shock absorbers and a larger front stabilizer bar. In addition, with the 390 or the 289 High-Perf. engines, a low restriction dual exhaust with bright-plated "quad" exhaust extensions is included.

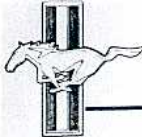

MUSTANG OPTIONS AND ACCESSORIES

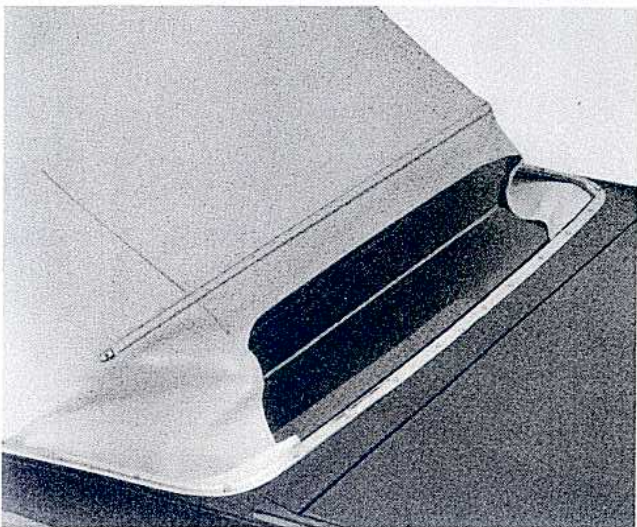
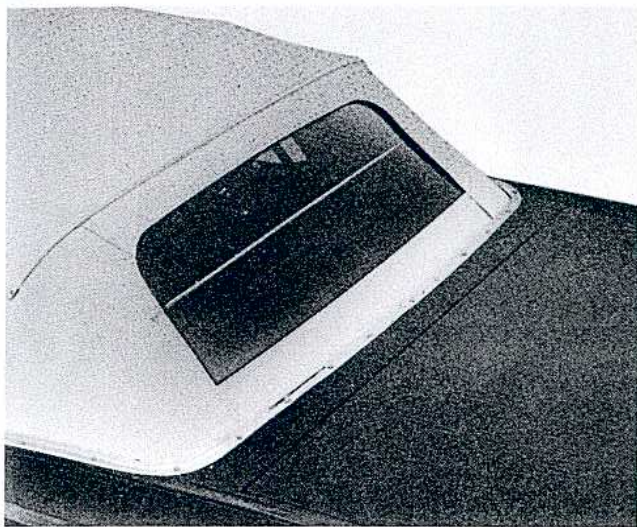

CONVERTIBLE ALL-GLASS REAR WINDOW — The all-glass rear window is available as an option on the 1967 Mustang Convertible. This represents a significant technical achievement, because of the limited space in the well behind the rear seat, insufficient to hold a large window. It has been accomplished by using a split rear window hinged horizontally with a strip of translucent rubber. The rubber hinge is a special silicone compound that resists aging, discoloration and cracking.

When the top is down, the window folds at the hinge line to store neatly below the convertible stack in the well. With the top up, the window has all the advantages of Sedan and Hardtop rear windows — resistance to scratching and discoloration and less distortion.

EXTERIOR DECOR GROUP — A new option, the Exterior Decor Group accentuates the sporty styling appeal of the basic Mustang. Included are hood louvers with integral turn signal lights visible to the driver, bright-metal molding around the wheel openings, and a fuel filler cap that pops open at the touch of a button. It also includes rear deck and quarter panel moldings on Hardtop and Convertible.

INTERIOR DECOR OPTION — A revised option for the 1967 Mustang, the Interior Decor Option adds a

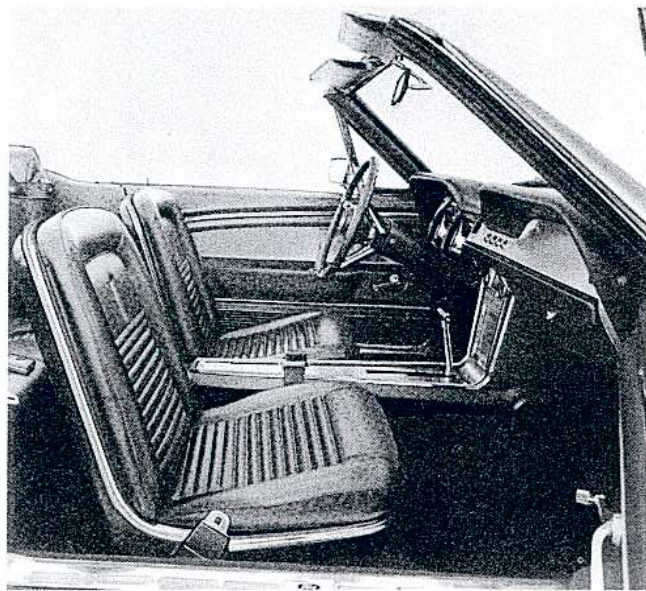

variety of elegant touches for interior luxury, rich appearance and increased safety. Included are molded door trim panels with integral arm rests, a smart horizontal theme grille on the lower door panels, a dual courtesy/rear warning lamp in the door panels, a molded roof console with two map lights (except Convertible), bright-metal trim on the foot pedals, attractive brushed aluminum appliques on the instrument panel and doors, and an electric clock in the instrument panel.

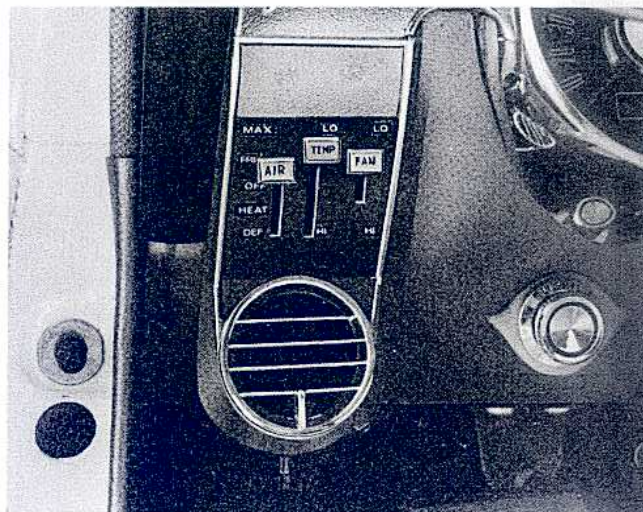

SELECTAIRE AIR CONDITIONER — The Select-Aire air conditioner is a deluxe unit fully integrated into the instrument panel and heating system. It is designed to provide year-round passenger comfort, obtained from one set of controls.

Four air conditioning registers are provided in the instrument panel, one at each end and two in the center. They are fully adjustable to obtain the most comfortable air distribution. For additional versatility, the unit features a three-speed blower and two air conditioning positions — a "Max Cool" (recirculating) and "Fresh" (fresh air). The reheat principle of air temperature regulation used in both positions results in maximum dehumidification and air circulation.

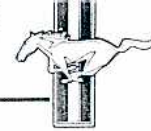

COMPLETE OPTION AND ACCESSORY AVAILABILITY

In the following list, availability of the various items is designated by RPO (Regular Production Options), LPO (Limited Production Options), or DLR (Dealer Installed Accessories).

	R P O	L P O	D L R
ENGINE OPTIONS — All models (See Power Team Selection Chart, page 4)	X		
TRANSMISSION OPTIONS — All models (See Power Team Selection Chart, page 4)	X		
TIRE OPTIONS — All models (See Tire Chart on page 11 for applications)	X	X	
POWER ASSISTS			
POWER DISC BRAKES — All models with V-8 engines	X		
POWER BRAKES — All models			X
POWER STEERING — All models except with 289 High-Perf. V-8	X		X
POWER TOP — Convertible	X		
PERFORMANCE EQUIPMENT			
AXLE RATIO OPTIONS — All models (See Power Team Selection Chart, page 4)	X		
BATTERY, 55 AMP. — Standard with 390 V-8 with Cruise-O-Matic	X		X
COMPETITION HANDLING PACKAGE — Ford 390 and 289 High-Performance V-8's with GT Equipment Group. Includes extra stiff front and rear springs, adjustable shock absorbers, extra heavy stabilizer bar, 16 to 1 ratio steering gear, high ratio rear axle with unique wheel covers, 6" rims, and 6.50/6.70 x 15 sports car 200 nylon tires.		X	
ENGINE GAUGE KIT — All models			X
EXTRA-COOLING PACKAGE — All engines. Standard with SelectAire.	X		
GT EQUIPMENT GROUP — All models with V-8 engines. Includes fog lamps, special ornamentation, power disc brakes, F-70-14 Wide-Oval WSW tires, H. D. Suspension, and GT Stripes — plus dual exhaust system with bright "quad" extensions on 390 and 289 High-Performance V-8.	X		
HEAVY-DUTY SUSPENSION — All models with V-8 engines. Includes increased rate front and rear springs, larger front and rear shock absorbers and larger diameter front stabilizer bar. (Std. with GT Equipment Group)	X		
LIMITED-SLIP DIFFERENTIAL — All models with V-8 engines	X		

	R P O	L P O	D L R
MIRROR, RACING-TYPE, EXTERIOR — All models			X
TACHOMETER AND TRIP ODOMETER — All models (6000 rpm except 8000 rpm with 289 High-Performance V-8)	X		
WHEELS, STYLED STEEL, 14" — All models with V-8 engines	X		
COMFORT/CONVENIENCE EQUIPMENT			
AIR CONDITIONER, FORD — All models			X
AIR CONDITIONER, SELECTAIRE — All models (N.A. with High-Perf. V-8)	X		
ARM RESTS, REAR — Hardtop			X
CIGARETTE LITE-LIGHTER — All models			X
CLOCK, ELECTRIC — All models	X		X
CLOTHES ROD — All models			X
COURTESY LIGHT GROUP — All models. Includes under hood, luggage compartment lights, and glove box lock. Hardtop models also include under dash and courtesy light.	X		
CONVENIENCE PANEL — Requires console when ordered with SelectAire — All models. Includes door ajar warning light, parking brakes light, low fuel warning light and seat belt light.	X		
DOOR STORAGE COMPARTMENT — All models			X
FIRE EXTINGUISHER — 2-3/4 or 5-pound dry chemical — All models			X
FLOOR MATS — Rubber or vinyl — Front or Rear — All models			X
GLASS BACKLIGHT — Folding — Convertible	X		
GLASS, TINTED, ALL WINDOWS — All models	X		
HEAD REST KIT — All models			X
LAMP, UTILITY PORTABLE — All models			X
LIGHT, ENGINE/TRUNK COMPARTMENT — All models			X
LIGHT, PARKING BRAKE WARNING — All models			X
LIGHT, REAR SEAT — Hardtop and Convertible			X
LITTER BASKET — All models			X
LUGGAGE RACK KIT, REAR DECK MOUNT — Hardtop and Convertible	X		X
MIRRORS — All models — — RIGHT-HAND, REMOTE — To match L.H. remote mirror — TRAILER TOWING			X
RADIO, AM, PUSH-BUTTON (Antenna included) — All models	X		
RADIO, AM/FM, PUSH-BUTTON (Antenna included) — All models	X		X
RADIOS AND ANTENNAS — TWO-WAY CITIZEN'S BAND — All models			X
RADIO SPEAKER, REAR, CONVENTIONAL AND STUDIOSONIC — Hardtop			X
SEAT, CHILD SAFETY — All models			X

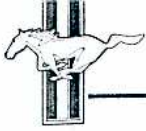

MUSTANG OPTIONS AND ACCESSORIES

	R P O	L P O	D L R		R P O	L P O	D L R
SEAT BELTS, DELUXE — Push button release with reminder light — all models	X			GRILLE, LOWER BACK PANEL — All models (Available only with Exterior Decor Group at extra cost)	X		
SEAT BELT, FOR 3RD PASSENGER — All models	X		X	ILLUMINATED MUSTANG GRILLE EMBLEM — All models			X
SEAT BELT, SHOULDER HARNESS, Front — All models. (Requires deluxe seat belts)	X			INTERIOR DECOR OPTION — All models. Includes molded door trim panels, padded quarter trim panels (Hardtop only), courtesy/warning light in doors, grille on door lower panels, roof console with map lights (Hardtop and Fastback), bright trim on foot pedals, brushed aluminum instrument panel appliques, vinyl covered "T" shift lever, bright buttons in seat backs, special ornamentation, and electric clock.	X		
SEAT CUSHION, VENTILATED — All models			X	MOLDING, ROCKER PANEL — (Std. on 2 + 2 Fastback)			X
SEAT, FULL-WIDTH WITH CENTER ARM REST, FRONT — Hardtop and Convertible (N.A. with Interior Decor Group)	X			PAINT, TWO-TONE — All models. Lower back panel dark grey only.	X		
SEAT, SPORT DECK OPTION, REAR — Fastback model only	X			PROTECTION GROUP — Color-keyed floor mats (front and rear), door edge guards, and license plate frames (front and rear).	X		
SPEED CONTROL, FINGERTIP — V-8 engine and Cruise-O-Matic required	X		X	TONNEAU COVER — Convertible			X
SPOTLIGHT — All models			X	VINYL ROOF — Hardtop (black or pastel parchment)	X		
STEREOSONIC TAPE SYSTEM (AM radio required) — All models	X		X	WHEEL COVERS, WIRE — All models	X		
TELEVISION 9-INCH, WITH ANTENNA AND HANGING BRACKET — All models			X	WHEEL COVERS — (Std. on 2 + 2 Fastback)	X		
TILT-AWAY STEERING COLUMN — All models	X			WHEEL TRIM RINGS — All models			X
TISSUE DISPENSER — All models			X	SPECIAL EQUIPMENT			
TRUNK RELEASE, REMOTE — All models			X	CRANKCASE EMISSION SYSTEM — Closed-type — All models (Requires exhaust emission control system)	X		
TURN SIGNALS, FENDER-MOUNTED — All models			X	ENGINE COOLANT HEATER, EXTERNAL TANK — All models			X
VACUUM CLEANER, 12-VOLT — All models			X	ENGINE COOLANT HEATER, PLUG-TYPE — All models			X
VEST, CHILD SAFETY — All models			X	EXHAUST EMISSION CONTROL SYSTEM — All models (Requires closed crankcase emission system)	X		
VINYL TRIM, VENTILATED (COMFORT-WEAVE) — Hardtop and Fastback (N.A. with full-width/arm rest front seat)	X			RADIATOR INSECT SCREEN — All models			X
APPEARANCE EQUIPMENT				TOOL KIT — All models			X
ACCENT STRIPE — All models	X			DELETE OPTIONS			
AIR HORNS — All models			X	HEATER, FRESH AIR — All models (Delete option except with SelectAire)		X	
CONSOLE — All models (Requires Radio)	X						
COVER PLATE, CONSOLE — All models			X				
DELUXE STEERING WHEEL — All models	X						
DOOR EDGE GUARDS — All models			X				
EXTERIOR DECOR GROUP — All models. Includes pop open fuel filler cap, louvered hood with turn signals, wheel opening moldings, rear deck and quarter panel moldings, on Hardtop and Convertible	X						
FRAME, LICENSE PLATE — All models			X				